



PIGNONI IN GHISA PER CATENE A RULLI - DIN 8187 - ISO 606

CAST IRON SPROCKETS FOR ROLLER CHAINS - DIN 8187 - ISO 606

3/8" x 7/32"
9,525 x 5,72 mm
Rullo 6,35 mm
06B - 1 - 2 - 3

B1 B2 B3 b1 C r3

5,3 15,4 25,6 5,2 1 10

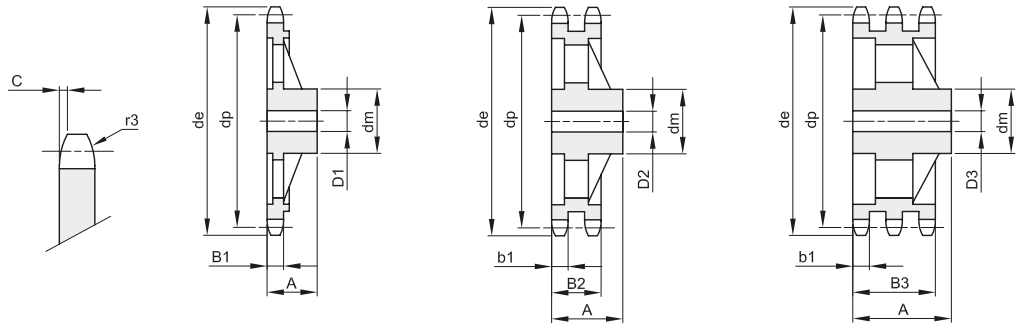

Materiale: Ghisa EN-GJL-200

Z	de	dp	semplici				doppi				tripli							
			codice	dm	D1	A	Kg.	codice	dm	D2	A	Kg.	codice	dm	D3	A	Kg.	
38	119,0	115,34	151330038	70	20	32	1,12											
45	141,1	136,54	151330045	70	20	32	1,30	152330045	80	20	40	2,06	153330045	90	24	56	3,56	
57	177,5	172,91	151330057	70	20	32	1,55	152330057	80	20	40	2,30	153330057	90	24	56	3,97	
76	235,1	230,49	151330076	70	20	35	2,00	152330076	80	20	40	3,02	153330076	100	24	56	4,52	
95	292,7	288,08	151330095	80	20	40	3,83	152330095	90	20	45	4,68	153330095	100	24	56	6,12	
114	350,3	345,68	151330114	80	20	40	4,05	152330114	95	20	45	5,90	153330114	100	24	56	10,19	

1/2" x 5/16"
12,7 x 7,75 mm
Rullo 8,51 mm
08B - 1 - 2 - 3

B1 B2 B3 b1 C r3

7,2 21 34,9 7 1,3 13

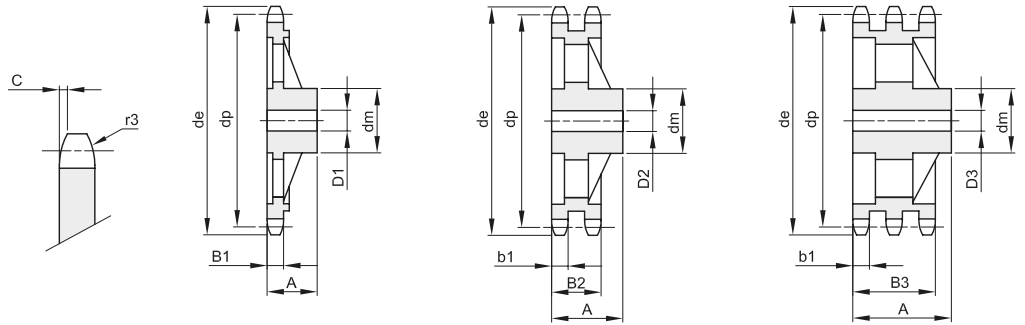

Materiale: Ghisa EN-GJL-200

Z	de	dp	semplici				doppi				tripli							
			codice	dm	D1	A	Kg.	codice	dm	D2	A	Kg.	codice	dm	D3	A	Kg.	
38	158,6	153,80	151340038	70	24	40	1,56	152340038	90	24	50	3,15	153340038	100	24	60	4,45	
45	188,6	182,07	151340045	70	24	40	1,95	152340045	90	24	50	3,56	153340045	100	24	60	5,85	
57	237,1	230,54	151340057	70	24	40	2,46	152340057	90	24	50	4,00	153340057	100	24	60	6,28	
76	313,9	307,33	151340076	80	24	40	4,20	152340076	100	24	56	6,35	153340076	100	24	60	8,60	
95	390,7	384,11	151340095	80	24	45	5,45	152340095	100	24	56	8,00	153340095	120	24	67	11,90	
114	467,4	460,90	151340114	80	24	45	8,35	152340114	100	24	63	11,90						



PIGNONI IN GHISA PER CATENE A RULLI - DIN 8187 - ISO 606

CAST IRON SPROCKETS FOR ROLLER CHAINS - DIN 8187 - ISO 606

5/8" x 3/8"
15,875 x 9,65 mm
 Rullo 10,16 mm
10B - 1 - 2 - 3

B1 B2 B3 b1 C r3

9,1 25,5 42,1 9 1,6 16

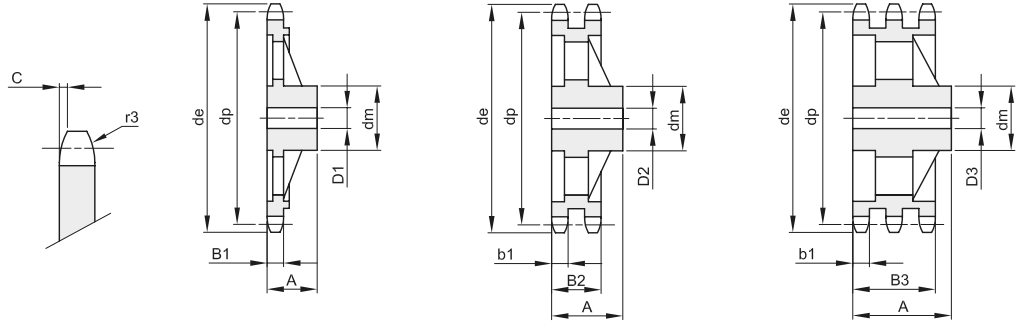

Materiale: Ghisa EN-GJL-200

Z	de	dp	semplici				doppi				tripli						
			codice	dm	D1	A	Kg.	codice	dm	D2	A	Kg.	codice	dm	D3	A	Kg.
38	199,1	192,24	151350038	80	24	40	2,32	152350038	100	30	50	4,56	153350038	100	32	60	6,50
45	236,0	227,58	151350045	80	24	40	2,88	152350045	100	30	50	4,93	153350045	100	32	60	7,04
57	296,6	288,18	151350057	90	24	45	4,30	152350057	100	30	56	6,50	153350057	100	32	63	8,00
76	392,5	384,16	151350076	90	24	50	7,00	152350076	100	30	63	9,10	153350076	110	35	67	12,00
95	488,5	480,14	151350095	100	24	56	10,65	152350095	110	30	63	12,60	153350095	125	35	70	19,40
114	584,5	576,13	151350114	100	24	56	14,50	152350114	125	30	70	17,80	153350114	125	35	80	24,00

3/4" x 7/16"
19,05 x 11,68 mm
 Rullo 12,07 mm
12B - 1 - 2 - 3

B1 B2 B3 b1 C r3

11,1 30,3 49,8 10,8 2 19

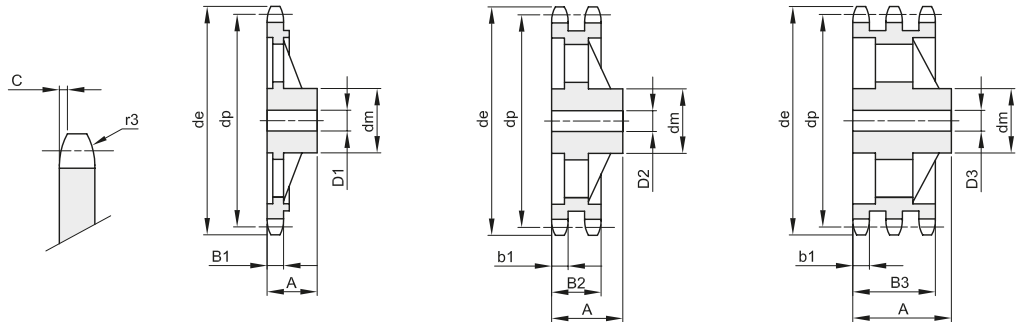

Materiale: Ghisa EN-GJL-200

Z	de	dp	semplici				doppi				tripli						
			codice	dm	D1	A	Kg.	codice	dm	D2	A	Kg.	codice	dm	D3	A	Kg.
38	238,9	230,69	151360038	100	24	56	4,75	152360038	110	25	63	7,50	153360038	115	30	70	10,00
45	283,2	273,10	151360045	100	24	56	5,90	152360045	110	30	63	8,30	153360045	140	30	70	13,30
57	355,9	345,81	151360057	100	30	56	6,45	152360057	120	30	63	10,30	153360057	140	40	70	15,25
76	471,1	460,99	151360076	100	30	56	12,30	152360076	135	30	63	15,20	153360076	160	40	75	27,20
95	586,2	576,17	151360095	100	30	65	15,40	152360095	135	30	70	20,20	153360095	170	40	82	36,40
114	701,4	691,36	151360114	100	30	65	17,50	152360114	135	45	70	30,40	153360114	170	50	82	41,10



PIGNONI IN GHISA PER CATENE A RULLI - DIN 8187 - ISO 606

CAST IRON SPROCKETS FOR ROLLER CHAINS - DIN 8187 - ISO 606

1" x 17,02 mm
25,4 x 17,02 mm
 Rullo 15,88 mm
16B - 1 - 2 - 3

B1 B2 B3 b1 C r3

16,2 47,7 79,6 15,8 2,5 26

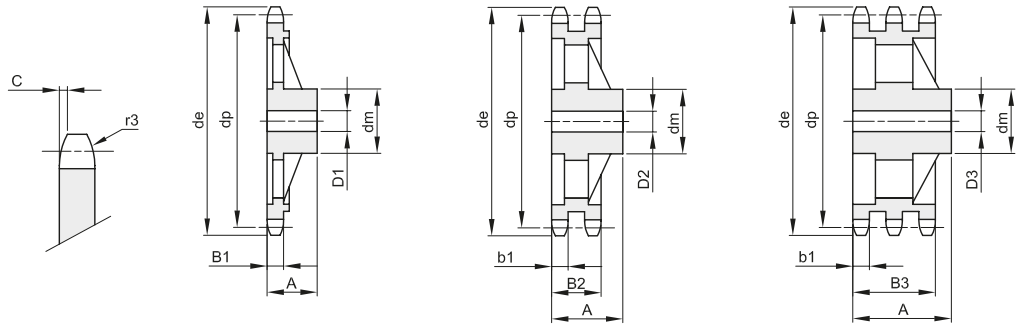

Materiale: Ghisa EN-GJL-200

Z	de	dp	semplici				doppi				tripli						
			codice	dm	D1	A	Kg.	codice	dm	D2	A	Kg.	codice	dm	D3	A	Kg.
38	319,2	307,59	151380038	110	30	65	8,26	152380038	140	40	75	16,45	153380038	160	45	100	25,40
45	377,9	364,12	151380045	125	30	70	10,75	152380045	150	40	75	19,20	153380045	160	45	100	33,60
57	474,9	461,07	151380057	125	35	70	12,90	152380057	170	40	90	29,50	153380057	180	45	100	44,70
76	628,4	614,65	151380076	140	35	80	24,70	152380076	175	40	95	46,30	153380076	200	45	110	63,10
95	782,0	768,22	151380095	140	40	80	32,00	152380095	175	45	95	53,00	153380095	200	50	110	77,00
114	935,6	921,81	151380114	150	40	80	45,50	152380114	180	45	95	74,00	153380114	200	50	115	97,00

1"1/4 x 3/4"
31,75 x 19,56 mm
 Rullo 19,05 mm
20B - 1 - 2 - 3

B1 B2 B3 b1 C r3

18,5 54,6 91 18,2 3,5 32

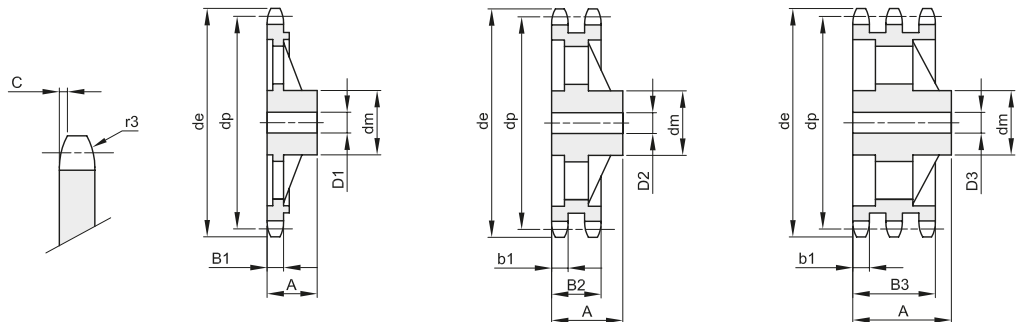

Materiale: Ghisa EN-GJL-200

Z	de	dp	semplici				doppi				tripli						
			codice	dm	D1	A	Kg.	codice	dm	D2	A	Kg.	codice	dm	D3	A	Kg.
38	399,4	384,49	151400038	125	35	70	12,30	152400038	140	45	90	24,80	153400038	180	50	115	52,00
57	592,3	576,36	151400057	135	40	80	25,60	152400057	170	50	100	43,00	153400057	180	50	130	71,50
76	784,3	768,32	151400076	140	50	90	29,10	152400076	180	50	110	62,50	153400076	200	50	140	115,00



PIGNONI IN GHISA PER CATENE A RULLI - DIN 8187 - ISO 606 CAST IRON SPROCKETS FOR ROLLER CHAINS - DIN 8187 - ISO 606

1"1/2 x 1"
38,1 x 25,4 mm
Rullo 25,4 mm
24B - 1 - 2 - 3

B1 B2 B3 b1 C r3

24,1 72 120,3 23,6 4 38

Materiale: Ghisa EN-GJL-200

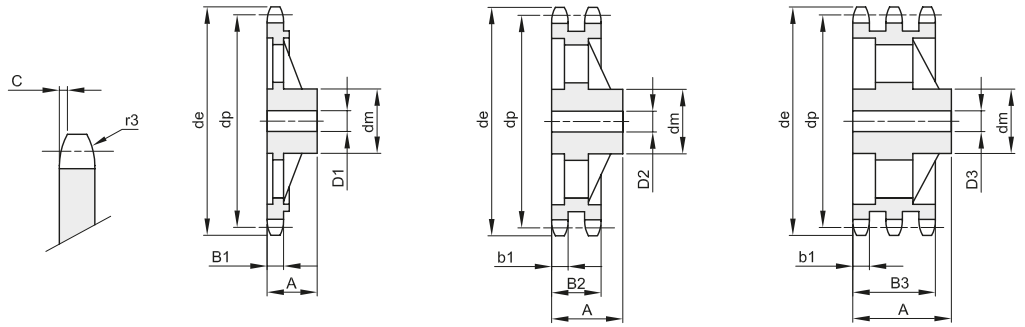

Z	de	dp	semplici				doppi				tripli						
			codice	dm	D1	A	Kg.	codice	dm	D2	A	Kg.	codice	dm	D3	A	Kg.
38	476,5	461,39	151420038	140	45	90	21,80	152420038	180	45	100	42,20	153420038	200	50	150	69,00
57	707,5	691,63	151420057	160	45	100	46,20	152420057	200	50	110	72,70	153420057	200	55	150	119,40
76	939,0	921,98	151420076	180	45	100	63,60	152420076	220	55	120	125,00					